

C8113 CAM LOCK

- 4 PIN TUMBLER
- 1 3/16" CYLINDER LENGTH
- FOR LIPPED APPLICATIONS

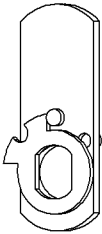
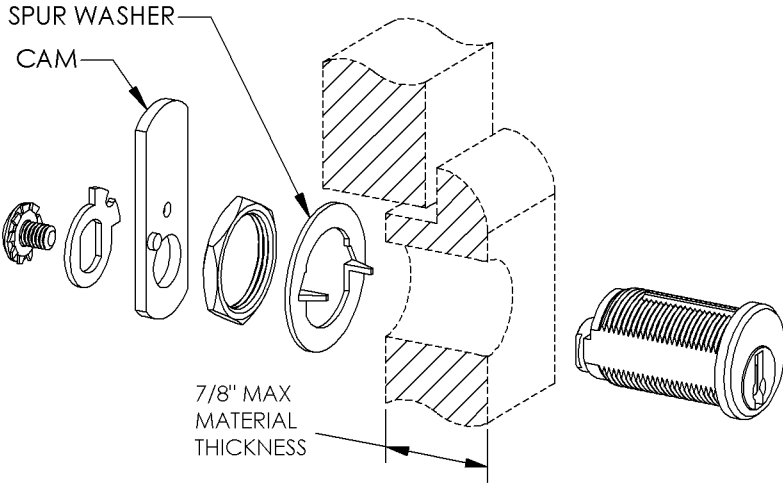

ASSEMBLED WITH
CAM FOR L.H. DOOR
OR CW DRAWER USE

NOTE: CAMS ARE NOT
REVERSIBLE



EXTRA CAM FOR
R.H. DOOR OR
CCW DRAWER
USE

CYLINDER MOUNTING HOLES

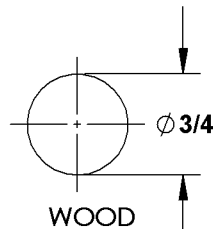
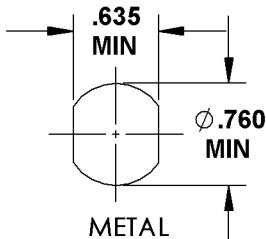

NOTE: DO NOT USE SPUR WASHER WITH METAL DOOR OR DRAWER